



CODONICS



European Authorized Representative:
AR Experts BV
Boeingavenue 209
1119 PD Schiphol-Rijk
The Netherlands
www.ar-experts.eu
SRN: NL-AR-000023989

SLS550i PCS Reference Guide

Table of Contents

Components	1
Hardware Setup.....	7
Startup	11
Loading Media	12
Login	16
Touch Screen User Interface.....	19
Printing a Syringe Label — Basic Use	20
Printing a Syringe Label — Advanced Operations	23
Monitoring Status.....	25
Maintenance	27
Installing Update Packages	31
Troubleshooting.....	33
Shutdown and Power Off.....	34

Components

Unpacked Components

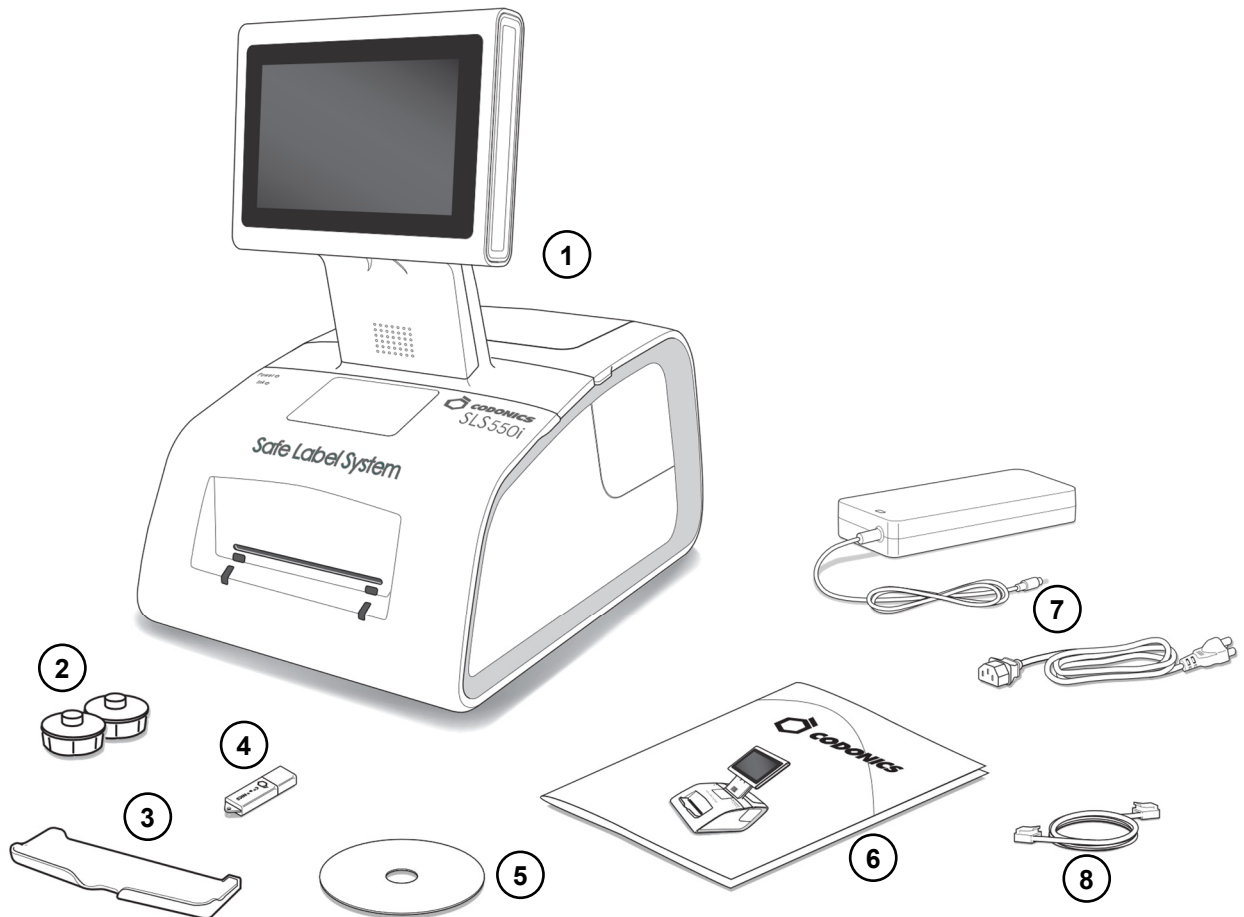

1. Safe Label System Point of Care Station (SLS PCS)
2. Label media hubs
3. Output bin
4. SmartDrive

5. User's Manual disc
6. Reference Guide and other documentation
7. External power supply and cord
8. Ethernet cable

Front Components

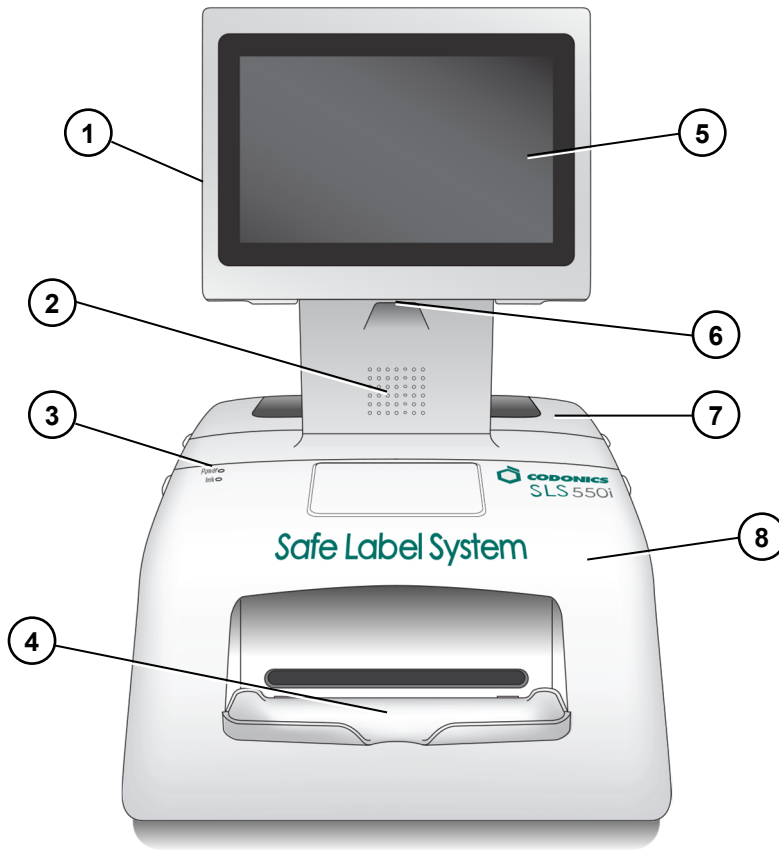

- | | |
|----------------------------|--------------------|
| 1. Touch screen USB port | 5. Touch screen |
| 2. Audio speaker | 6. Barcode scanner |
| 3. System power LED | 7. Rear cover |
| 4. Output tray (installed) | 8. Front cover |

Components Inside Front Cover

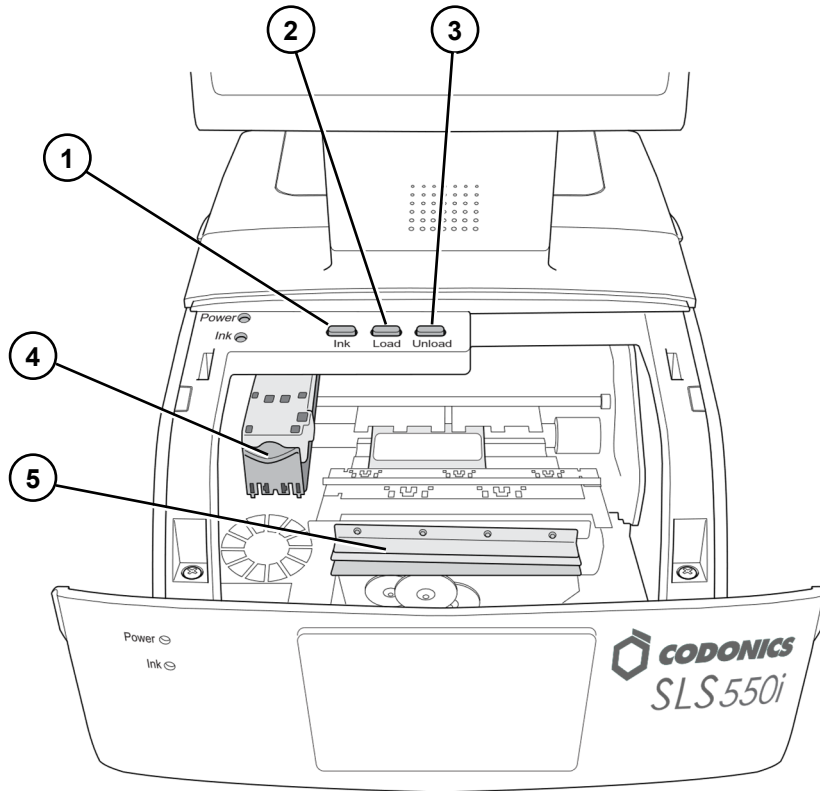

- | | |
|------------------|---------------------------|
| 1. Ink button | 4. Ink cartridge carriage |
| 2. Load button | 5. Label cutter |
| 3. Unload button | |



WARNING: When the front cover is open, avoid contact with the label cutter.

Rear Components

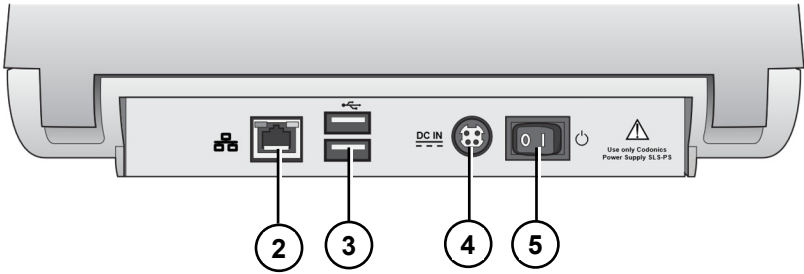
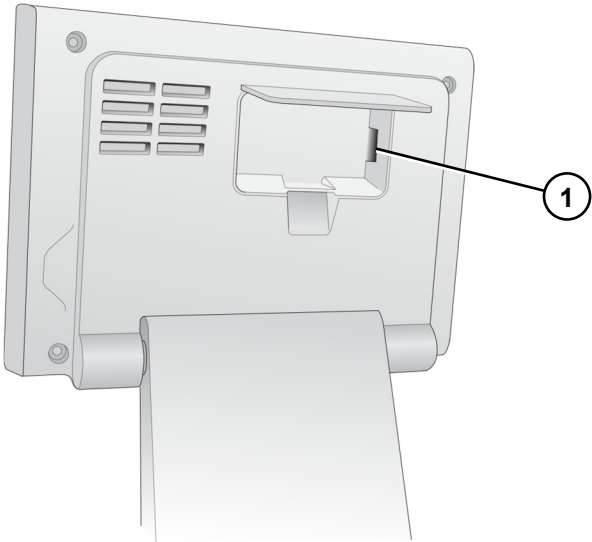

- 1. SmartDrive USB port
- 2. Ethernet port
- 3. USB ports
- 4. Power input port
- 5. Power switch

Touch Screen Components

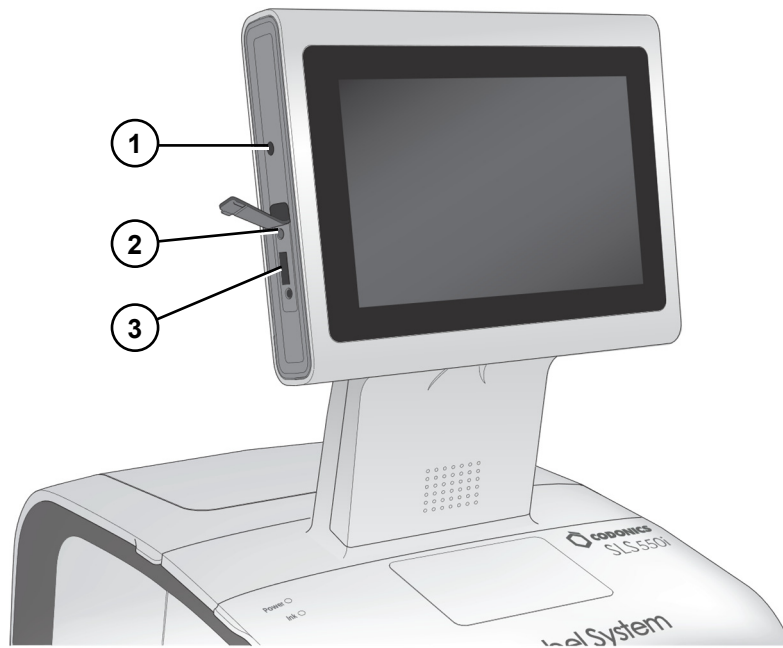

- 1. Power LED
- 2. Reset button

- 3. USB port

Wi-Fi Adapter USB Port

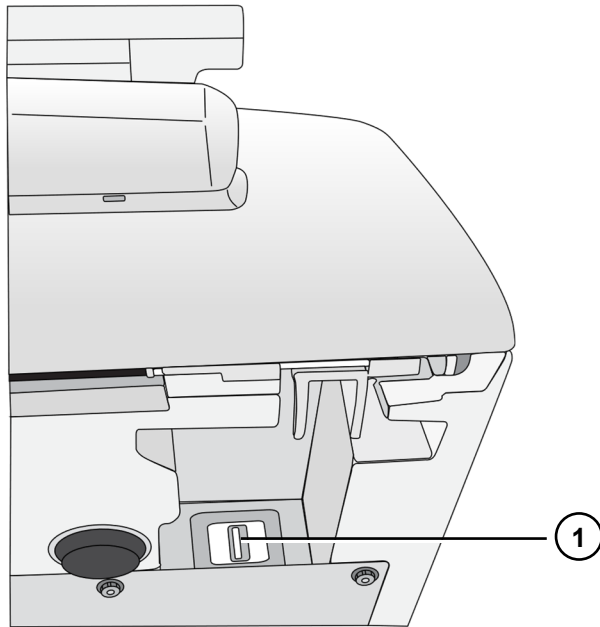

1. USB port for Wi-Fi adapter (bottom front right corner of SLS PCS)

Hardware Setup



CAUTION: Only trained users should install and configure the system.

Ethernet Cable (Optional)

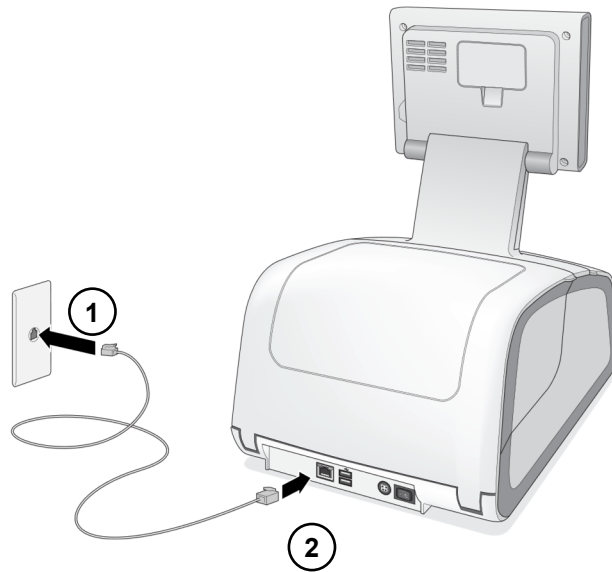

1. Connect the Ethernet cable to a hub or outlet that is connected to the network.
2. Connect the other end of the Ethernet cable to SLS PCS.

NOTE: For information about configuring SLS PCS Ethernet network settings, refer to the SLS 550i PCS User's Manual v3.0.0.

Wi-Fi Adapter (Optional)

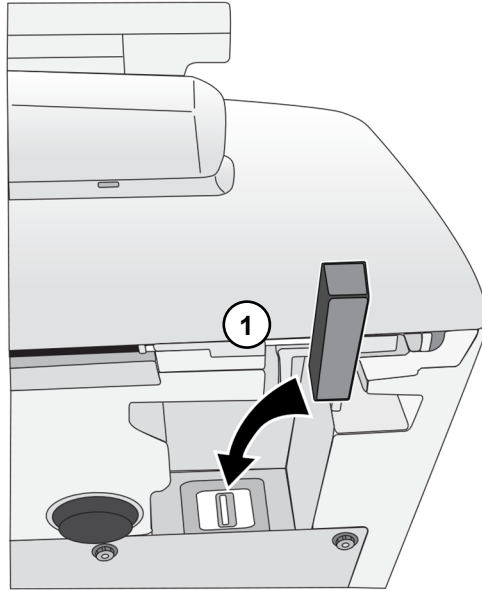

1. Insert the Wi-Fi adapter into the USB port at the bottom front right corner of SLS PCS.

NOTE: For information about configuring SLS PCS Wi-Fi network settings, refer to the SLS 550i PCS User's Manual v3.0.0.

Power, SmartDrive

1. Place SLS PCS on a solid level surface.

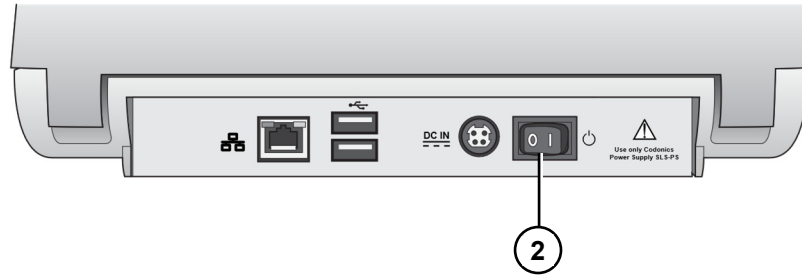

2. Turn the Power switch to off.

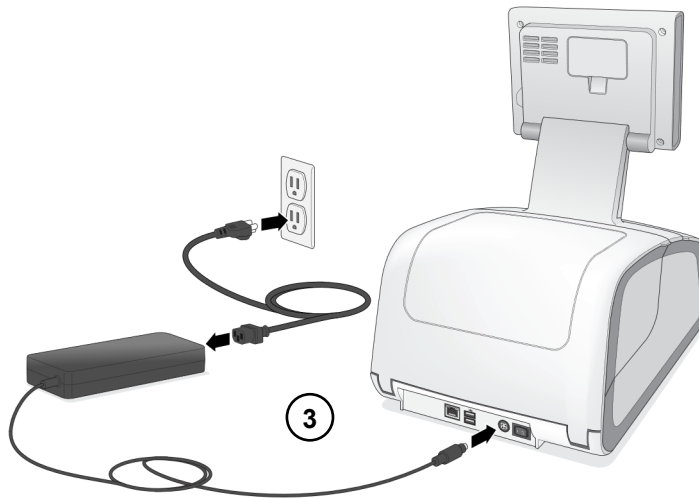

3. Connect the external power supply.



WARNING: The power cord connected to SLS PCS is the main disconnect for the system.



WARNING: Grounding reliability can be achieved only when SLS PCS is connected to a receptacle marked "Hospital Only" (that is, "Hospital Grade").



WARNING: Do not touch a patient while also accessing SLS PCS internal components that are under the access covers.

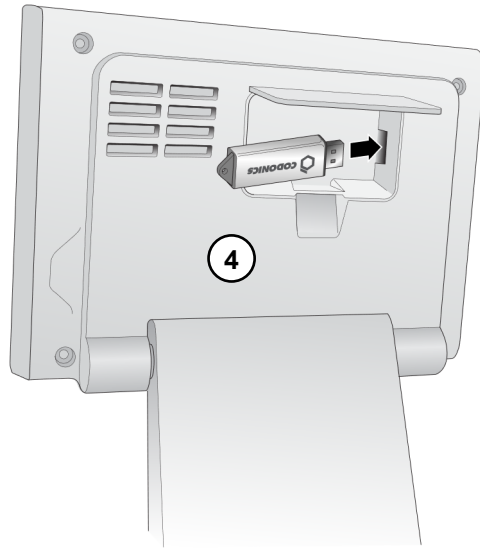

4. Insert the SmartDrive.

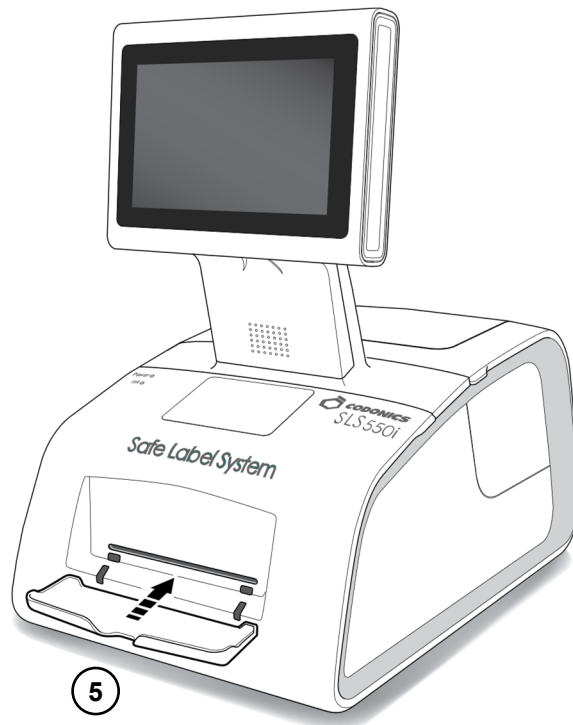

5. Insert the output tray.

Startup

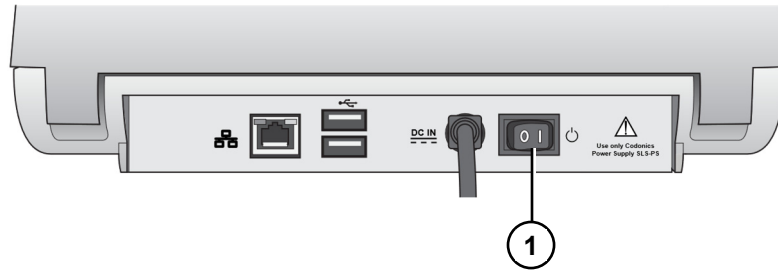

1. Turn on the Power switch.

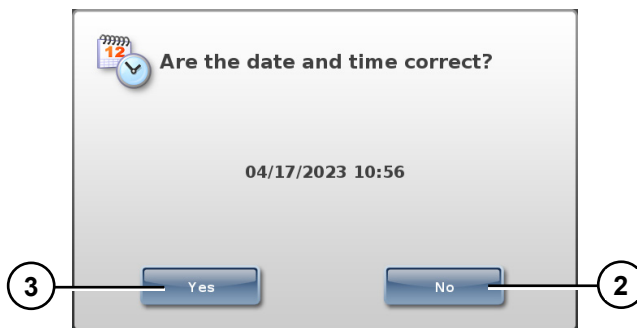

2. To adjust the date and time, press No.

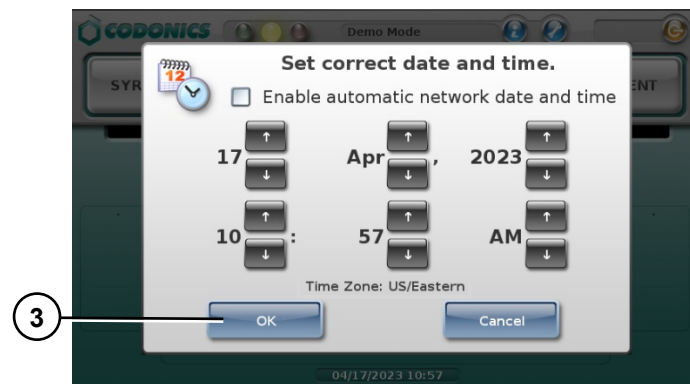

3. If the date and time are correct, press Yes on the confirmation screen or OK on the date/time setting screen.

The Login prompt displays.

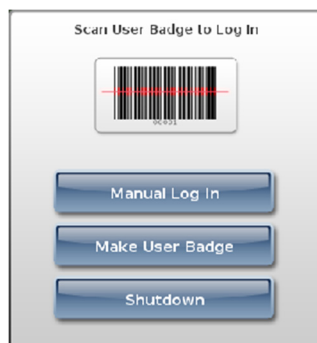

Loading Media

NOTE: Use only Codonics-supplied media.

To order media, contact Codonics Customer Service at:

Phone: +1.440.243.1198
Fax: +1.440.243.1334
Toll Free: +1.800.444.1198
Web Site: www.codonics.com

Installing the Ink Cartridge

1. Open the front cover.

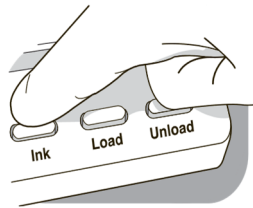

2. Press the Ink button.
3. Wait for the ink cartridge carriage to finish moving.

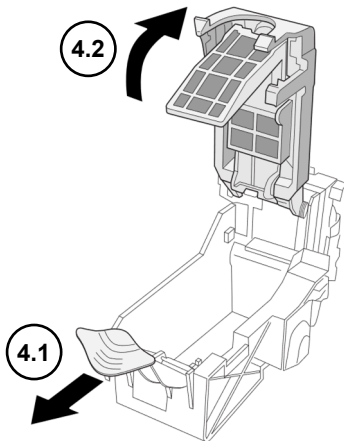

4. Carefully open the ink cartridge carriage.

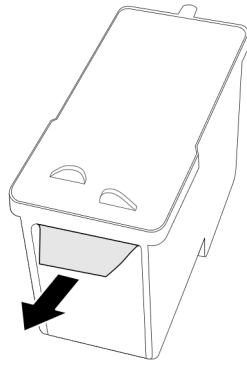

5. Remove the tape that covers the ink cartridge print head.

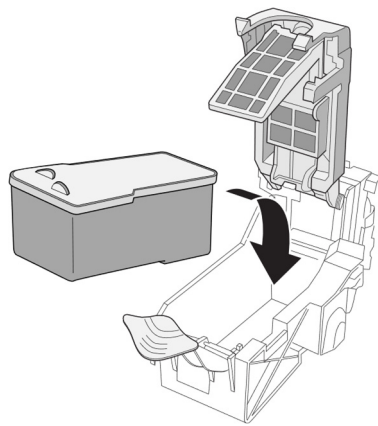

6. Install the ink cartridge.

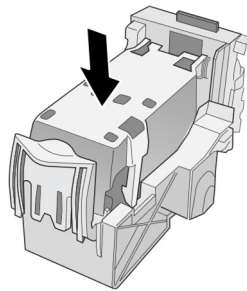

7. Close the ink cartridge carriage.

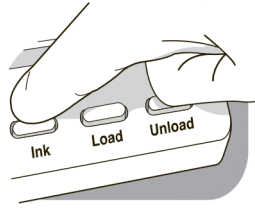

8. Press the Ink button.
9. Close the front cover.

Loading Label Media

1. Open the rear cover.

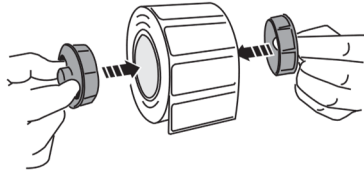

2. Insert the label media hubs.

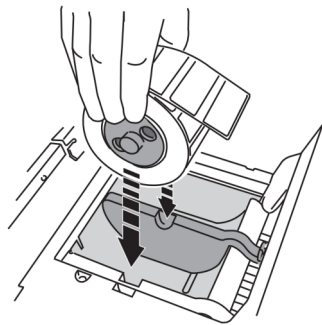

3. Place the label media and hubs in the media guides.
4. Adjust the media guides. Label media should be secure but still able to turn freely.

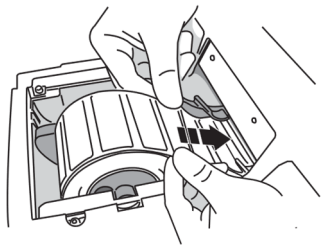

5. Place the label media below the media guides and into the feeder slot.

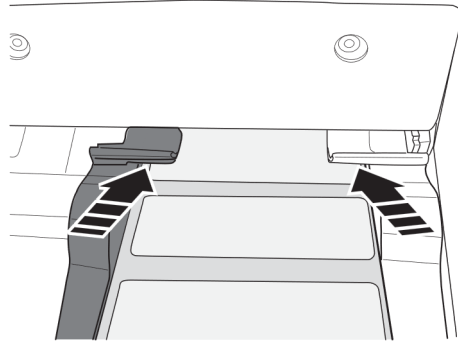

6. Feed the label media until SLS PCS automatically feeds it through the media path. You might need to hold the label media in place for a few seconds.

NOTE: If SLS PCS fails to feed the label media, open the front cover, press the Unload button, remove the media from the media path, wait until the media path rollers stop spinning, and try loading the media again.

7. Close the rear cover.

Login

Making a User Badge

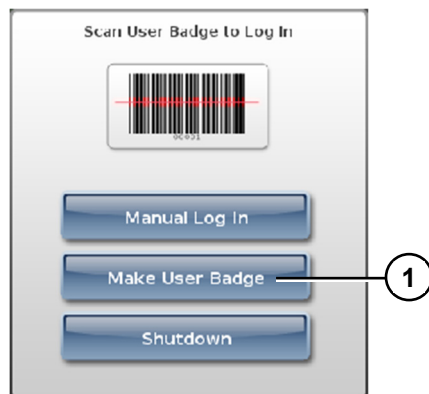

1. At the Login prompt, press the Make User Badge button.

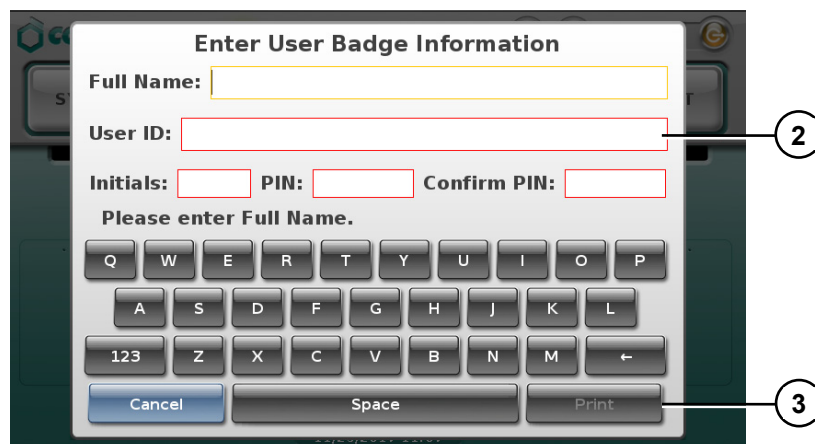

2. Enter your user information.

NOTE: The Employee ID must be unique among SLS PCS users.

NOTE: The PIN can be up to ten digits long. If the system is not configured to require a PIN, then you will not be prompted to enter a PIN.

3. Press the Print button.

Logging In

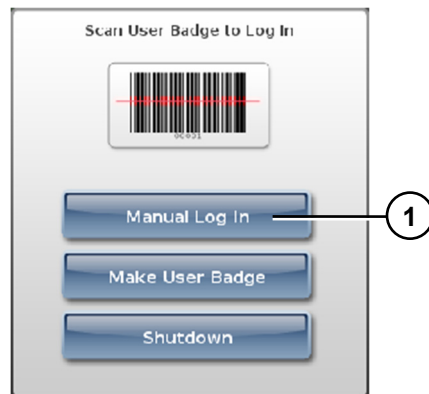

1. At the Login prompt, scan your user badge barcode or manually enter your user ID.

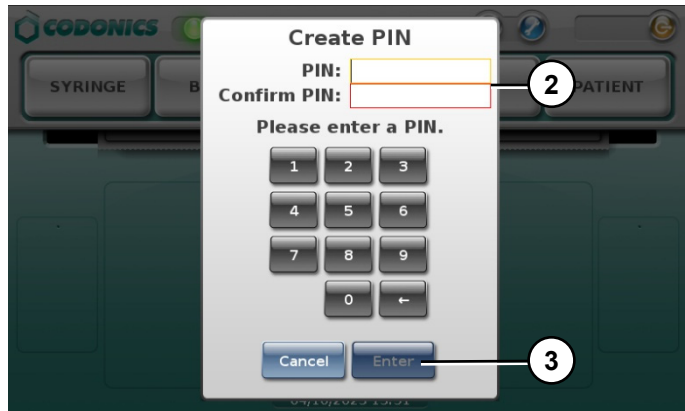

2. If the system is configured to require a PIN, enter your PIN.

NOTE: The PIN can be up to ten digits long.

3. Press the Enter button.

If a test label is printed, you are prompted to confirm that the test label printed correctly.

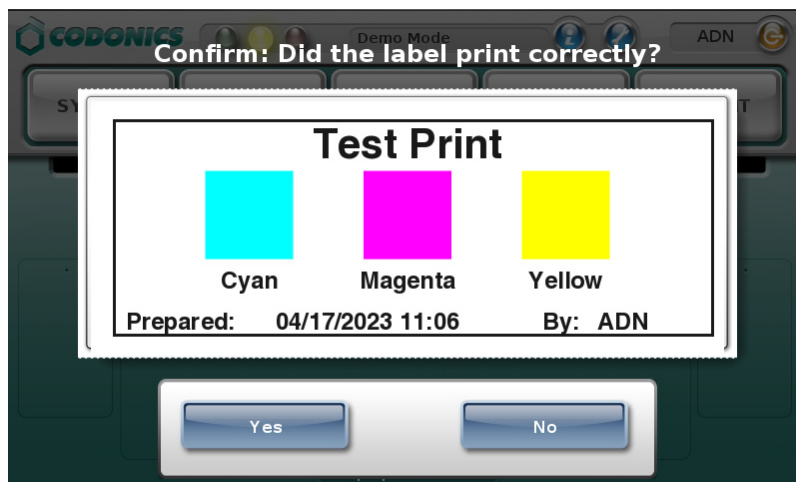

4. Inspect the test label.
5. If the test label printed correctly, press the Yes button. The system is ready for use.

If the test label did not print correctly, press the No button. Follow the on-screen instructions.

Touch Screen User Interface

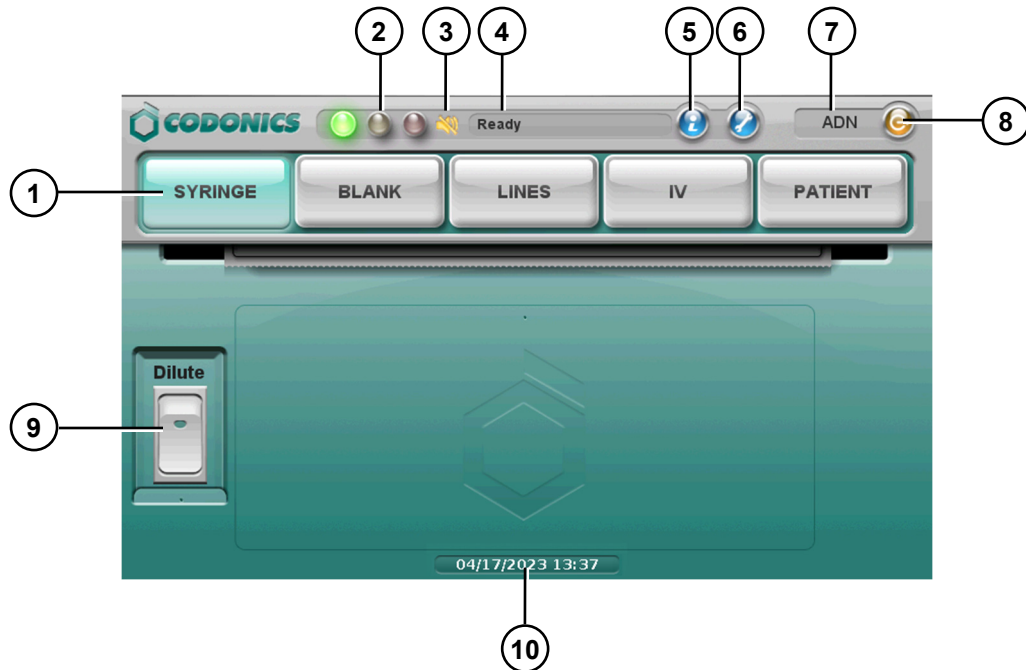

1. Label type buttons
2. LED status indicators
3. Volume Muted icon
4. System status message
5. System information button
6. Utilities button
7. User initials
8. Logout button
9. Dilute switch
10. Current date and time

Printing a Syringe Label – Basic Use



CAUTION: The formulary used on SLS PCS should be one that was created by the System Administrator and approved for use.



1. Press the Syringe label button.
2. To include dilution information, press the Dilute switch to turn it on.

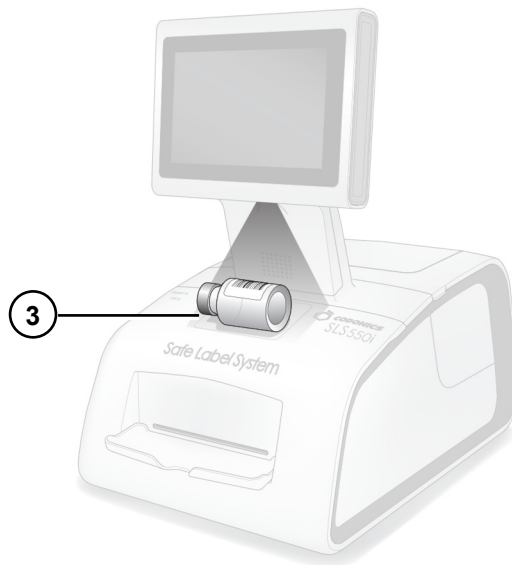

3. Scan the drug container barcode.



4. If the Choose a Dilution prompt displays, select a concentration and diluent.



WARNING: SLS PCS users are responsible for calculating and selecting the correct concentration and diluent.

5. Press the OK button.

If the system is configured to require confirmation before printing the label, a confirmation prompt displays.



NOTE: The label confirmation prompt is displayed for safety reasons to ensure that the correct drug information is being printed.

6. Press the Print button to confirm and print the label.

7. Retrieve the printed label from the output bin.

If the system is configured to require confirmation after printing the label, a confirmation prompt displays.



NOTE: The label confirmation prompt is displayed for safety reasons to ensure that the label has been printed correctly.

8. After reviewing the label and the screen display, perform one of the following steps:

- Scan the barcode on the printed label. If the barcode is correct, the system will indicate it was successful and the procedure is complete.
- If you can see that the label did not print correctly, press the No button. Follow the on-screen instructions.
- If you are not able to scan the barcode, press the Unable to Scan button. Follow the on-screen instructions.



WARNING: To avoid mislabeling syringes, make sure that you immediately affix the correct label to the appropriate syringe.



WARNING: Incorrect syringe labels should be destroyed or disposed of per your hospital policies and procedures to ensure that they are not used.

Printing a Syringe Label – Advanced Operations

Matching Container IDs

After scanning the drug container barcode, if there are multiple matching drugs with the same Container ID, they are displayed.

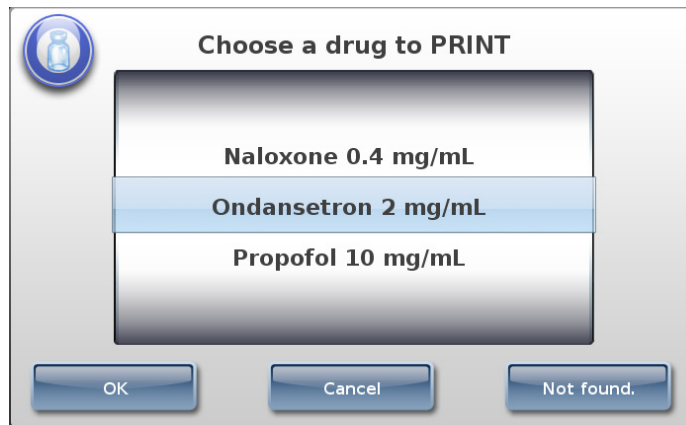

- If the correct drug is displayed, select it and then press the OK button.
- If the correct drug is not displayed, press the Not Found button. The procedure ends. Contact your SLS PCS System Administrator or Codonics Technical Support (+1.440.243.1198).
- To cancel the operation, press the Cancel button.

Mapped Master IDs (USA Only)

After scanning the drug container barcode, if the Container ID that was scanned can be mapped to more than one Master ID, those drugs are displayed.

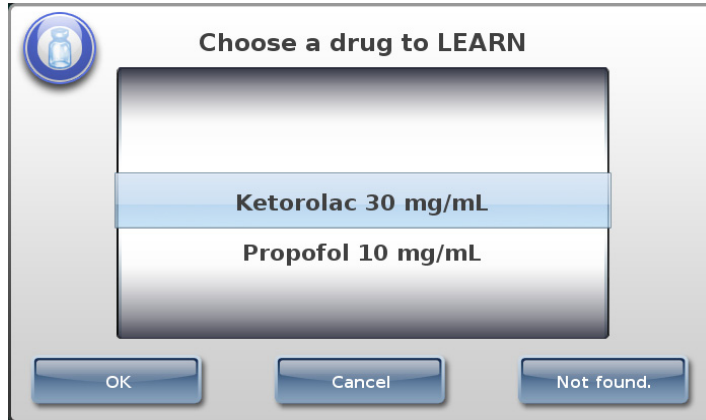

- If the correct drug is displayed, select it and then press the OK button.
- If the correct drug is not found, press the Not Found button. The procedure ends. Contact your SLS PCS System Administrator or Codonics Technical Support (+1.440.243.1198).
- To cancel the operation, press the Cancel button.

Drug Verification

If the drug has not been previously verified to ensure that the drug container information is the same as the drug information in the formulary, a verification prompt displays.

NOTE: The verification prompt only occurs once for each drug, when its container barcode is scanned for the first time.

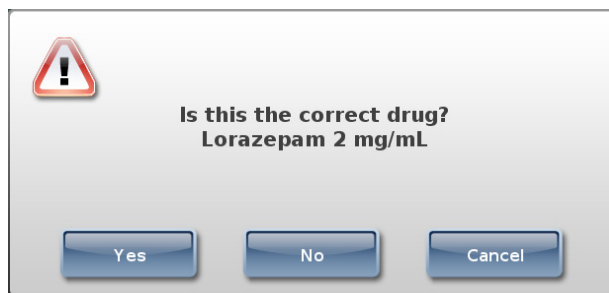

- If the drug information is correct, press the Yes button. You are prompted again to confirm that the drug information is correct.
- If the drug information is not correct, press the No button. You are prompted again to confirm that the drug information is incorrect.
- To cancel the operation, press the Cancel button.

Monitoring Status

Dashboard Status Information

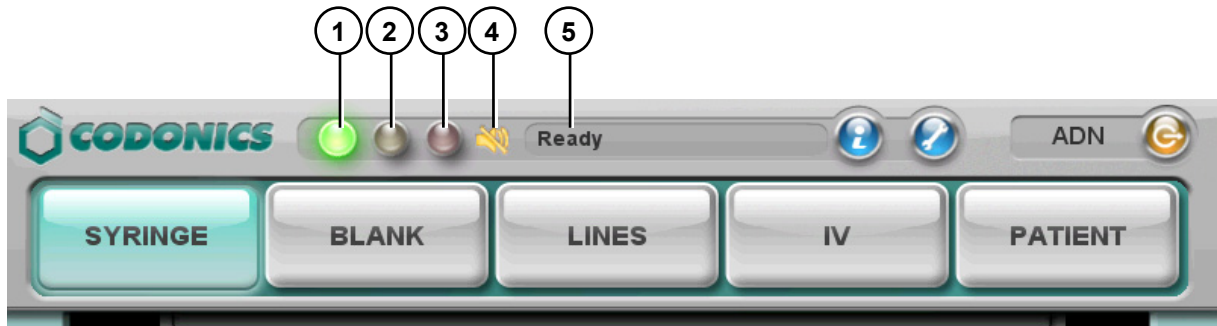

1. **Normal:** The system is ready to process or is processing a job (for example, printing).
2. **Alert condition:** The system can still process jobs but requires user attention (for example, low ink).
3. **Critical or fault condition:** The system might not be able to process jobs. The system requires immediate user attention (for example, out of label media).
4. **Muted icon:** Displays when the volume is muted.
5. **Status messages.**

System Information

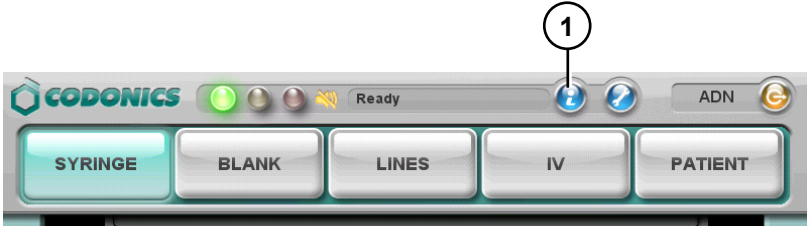

1. Press the System Information icon.



2. Press the tabs to view additional information.

For descriptions of each tab, refer to the SLS 550i PCS User's Manual v3.0.0.

Maintenance

Displaying the Utilities Screen

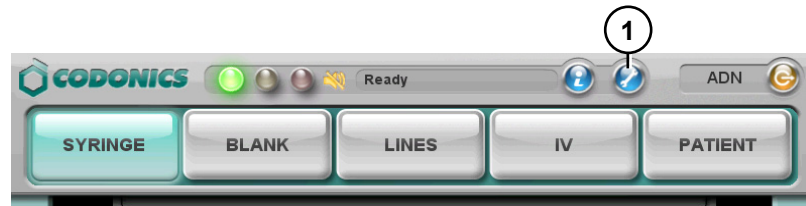



1. Press the Utilities button.

The Utilities screen displays. The buttons are described in the table below.



2. To close the Utilities screen, press the Utilities button again.

Utility Button	Description
Clean Nozzles	Cleans the ink cartridge nozzles.
Adjust Label	Allows you to adjust the label printing position to ensure that label content is properly centered on the label.
Dark Print: Off or On	Sets dark printing of black text to off or on.
Fast Print: Off or On	Set fast printing, which uses fewer ink passes to print labels, to off or on.
Print My Badge	Prints a user badge for the user who is currently logged in.
Calibrate Screen	SLS550i screen does not require calibration, so this option is not functional.
Calibrate Printer	Calibrates the media path and the paper out sensor.
Network	Allows you to configure the network settings.

Utility Button	Description
Copy Logs	Copies system logs to a USB flash drive that is inserted in the USB port on the side of the touch screen.
Clear Errors	Clears system errors. This setting should only be used by System Administrators after the errors are carefully reviewed.
Manage Features	Allows you to add SLS PCS features.
Date/Time	Sets the date and time.
	Adjusts the touch screen brightness.
	Adjusts the audio volume.

Clearing a Label Jam

1. Remove your gloves.
2. Open the front and rear covers.
3. Identify the location of the jammed media and use the appropriate procedure below.

Clearing a Label Jam in the Front Media Guide

1. Gently remove the label media from under the front guide by pulling up the label media near the ink carriage.



CAUTION: Avoid peeling up a label in the media path. You might have to pull the media forward through the cutter to avoid peeling a label. If a label is peeled up in the media path, do not press the adhesive side of the label against the sheet metal guides.

2. Use scissors to cut the liner between two labels by the ink carriage to allow you to remove the jammed label media.

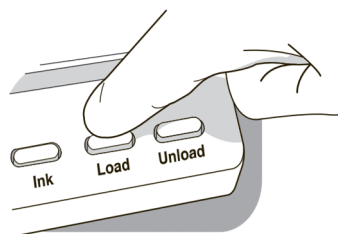

If required, press the Load button to advance the label media.

NOTE: Scissors are recommended for cutting the liner so that the label media will have a straight edge. The straight edge will make loading the label media easier.

3. Gently remove the jammed portion of the label media.
4. Review the strip of labels. Make sure that you can account for all of the labels and that no labels are stuck in the front media guide. Discard the damaged label media.
5. If portions of the label media are still jammed in the media path, power off the system (refer to “Shutdown and Power Off” on page 34). Use non-metallic tweezers and carefully remove any additional label media from the media path.

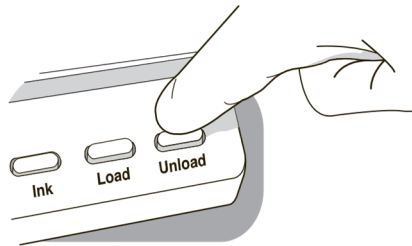

6. Press the Unload button to reverse any portion of the label media that is still in the media path.
7. Inspect the label media. Use scissors to cut off any damaged labels.
8. Close the front cover, load the label media, and close the rear cover.

Clearing a Label Jam in the Rear Media Guide

1. Identify the location of the jammed media under the rear media guide.

The rear media path can be exposed by using the thumb screws to remove the rear media guide cover.

2. Use scissors to cut the liner between two labels by the ink carriage. This will reduce the number of labels being pulled back through the media path.
3. Gently remove the cut portion of the label media from the front media guide and discard it.
4. Use scissors to cut the liner between the jammed portion of the label media and the label media roll.

NOTE: Scissors are recommended for cutting the liner so that the label media will have a straight edge. The straight edge will make loading the label media easier.

5. Gently remove the jammed portion of the label media.



CAUTION: Avoid peeling up a label in the media path. If a label is peeled up in the media path, do not press the adhesive side of the label against the sheet metal guides.

6. Review the strip of labels. Make sure that you can account for all of the labels and that no labels are stuck in the rear media guide. Discard the damaged label media.
7. If portions of the label media are still jammed in the media path, power off the system (refer to “Shutdown and Power Off” on page 34). Use non-metallic tweezers and carefully remove any additional label media from the media path.

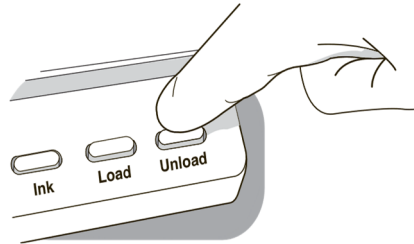

8. Press the Unload button to reverse any portion of the label media that is still in the media path.
9. Inspect the label media. Use scissors to cut off any damaged labels.
10. Close the front cover, load the label media, and close the rear cover.

Installing Update Packages

Use this procedure to manually install formulary update packages and configuration update packages.

NOTE: Formulary and configuration update packages can also be installed remotely using the Administration Tool. For more information, refer to the SLS Administration Tool User's Manual.



CAUTION: Installing system software should only be performed as directed by Codonics Technical Support. Do not attempt to install system software without the assistance of Codonics Technical Support.

1. Log in.
2. Make sure that SLS PCS is not processing any print jobs or utilities.

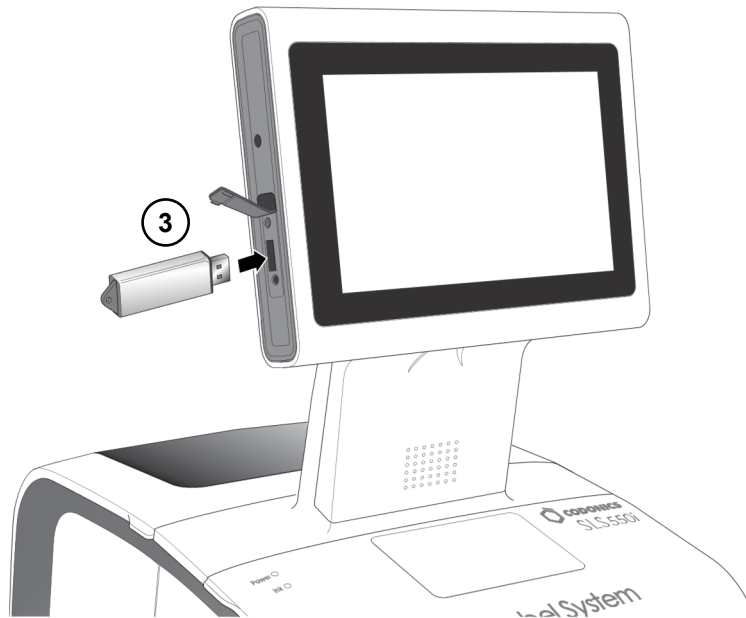

3. Insert the USB flash drive on which the update package or software is installed.

You are prompted to confirm the installation.

4. Press the Yes button to continue.
5. When the installation files have been copied, remove the USB flash drive.

When the installation is complete, the system restarts automatically.



CAUTION: SLS PCS customer is responsible for ensuring that the correct formulary and configuration packages are being installed on SLS PCS.





CAUTION: Practice standard information technology (IT) precautions to protect data associated with the formulary (for example, securing the content of the USB flash drive on which the formulary update package is stored).



CAUTION: SLS PCS customer is responsible for the accuracy of the data in the formulary, including drug data that has been copied from third-party drug databases.

Troubleshooting

Problem	Solution
Startup fails.	<p>Check the external power supply and cables.</p> <p>Check the power switch on the rear panel.</p> <p>Verify that the SmartDrive is connected.</p>
System will not power on.	<p>Replace the external power supply.</p>
Login fails.	<p>Verify the user name.</p> <p>Verify the PIN.</p> <p>Verify that the user badge is correct and that its barcode quality is satisfactory.</p>
The touch screen does not respond properly when touched.	<p>Potential hardware problem. Contact Codonics Technical Support (+1.440.243.1198).</p>
The formulary fails to load or is invalid.	<p>A new formulary update package might have to be created and loaded. See your SLS PCS System Administrator.</p>
A drug container failed verification.	<p>The drug might have to be added to or corrected in the formulary.</p> <p>Make sure that the barcode on the drug container is of good quality.</p> <p> CAUTION: This is a serious issue. Notify your SLS PCS System Administrator.</p>
A test label or syringe label did not print correctly.	<p>Discard the label and try again.</p> <p>If the label print quality is bad:</p> <ul style="list-style-type: none"> • Run the Clean Nozzles utility. • Replace the ink cartridge. • Replace the label media. <p>If the print is not aligned properly on the label, run the Adjust Label utility.</p> <p>If the wrong drug information is printed on the label, the drug might have to be corrected in the formulary. See your SLS PCS System Administrator.</p> <p> CAUTION: This is a serious issue. Notify your SLS PCS System Administrator.</p>
The barcode scanner is not scanning.	<p>Make sure the barcode is correctly positioned. The red cross-hair should line up with the barcode and the container or syringe should be as close to the front cover as possible.</p> <p>Shutdown the system from the touch screen and then cycle power to the system.</p> <p>Make sure the quality of the barcode is good.</p> <p>Clean the scanner's glass window.</p> <p>The barcode symbology might not be supported. Contact Codonics Technical Support (+1.440.243.1198).</p>
The label media is jammed.	<p>Clear the label jam. Refer to "Clearing a Label Jam" on page 28.</p>
SLS PCS will not connect to the network.	<p>Verify that the Ethernet cable or Wi-Fi adapter is connected.</p> <p>Verify that SLS PCS network settings are configured properly.</p>

NOTE: For additional troubleshooting issues, refer to the SLS 550i PCS User's Manual v3.0.0.

Shutdown and Power Off



WARNING: When SLS PCS is powered on, do NOT unplug SLS PCS from the power outlet to power it down. Shut down from the SLS PCS properly per the instructions here and in the SLS550i PCS User's Manual v3.0.0.

1. Make sure all print jobs have completed.

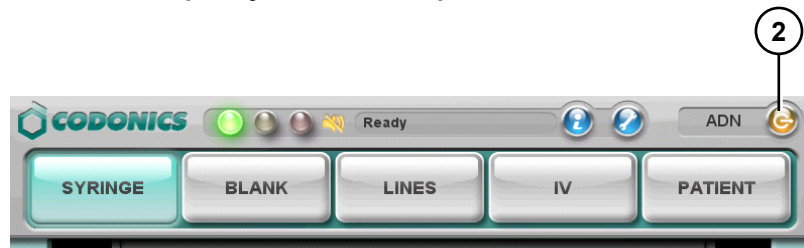

2. Press the Log Out button.

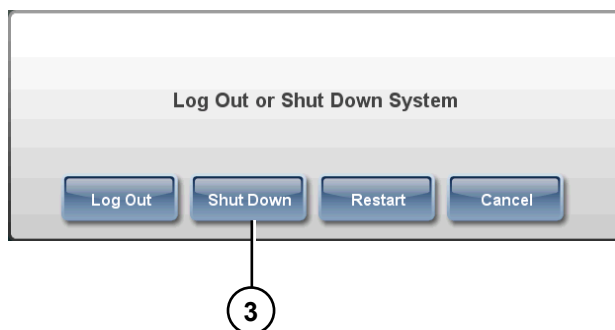

3. Press the Shut Down button.

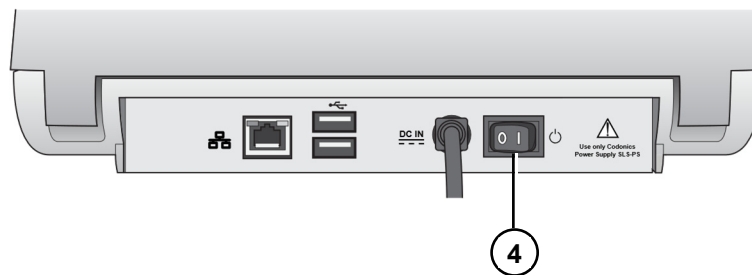

4. When shutdown is complete, turn off the Power switch.

All registered and unregistered trademarks are the property of their respective owners. Specifications subject to change without notice. Patents: www.codonics.com/ip/patents. Copyright © 2010 – 2026 by Codonics, Inc. Printed in U.S.A. Part Number 900-539-009.02